

CE EN 13561 : CLASS 3

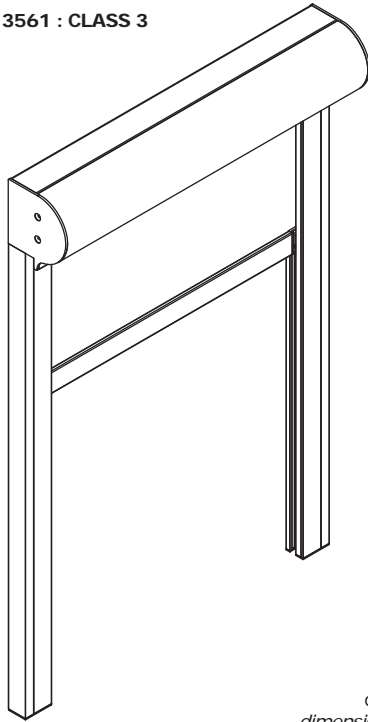

dimensioni in mm
dimensions shown in mm

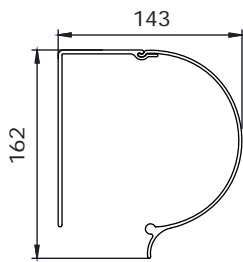

CV140

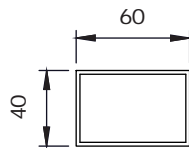

tubolare
per fissaggio a soffitto
rectangular frame
for ceiling mounting

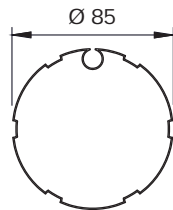
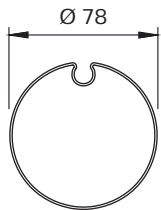

rulli - tubes

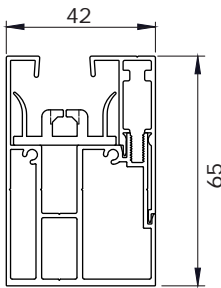

GS65

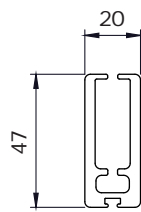

FZ47

varianti - optional

guarnizione anti-pioggia in PVC (bianco, grigio, nero) per fondale FZ47

PVC waterproof strip (white, grey, black) for FZ47 hem bar

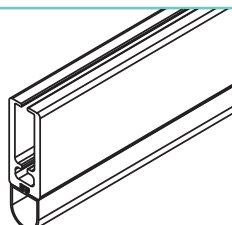

CARATTERISTICHE:

Tipo di applicazione: verticale

Ambiente di applicazione: esterno/interno

Cassonetto: CV140 in alluminio estruso di grande spessore e molto rigido, composto da una parte fissa e una mobile ispezionabile; coppie di testate laterali in alluminio pressofuso verniciato in tinta con il cassonetto

Rullo di avvolgimento: Ø 78/85 mm in acciaio zincato con ogiva per agevolare la manutenzione del telo

Guide: GS65 con profilo di chiusura in alluminio estruso e anima interna con alette in PVC per un perfetto scorrimento e trattenimento del telo in guida. Le guide del sistema ZIP garantiscono oscuramento totale ove richiesto

Fondale: FZ47 piatto in alluminio estruso zavorrato con profilo in ferro zincato, completo di tappi scorrevoli in PVC e spazzolino. A richiesta profilo in gomma anti-pioggia (bianco, grigio, nero)

Manovra: a motore tubolare monofase 230V/50Hz M50, completo di fine corsa meccanico e cavo di alimentazione, protezione termina, indice di protezione agli spruzzi d'acqua IP44. Interruttore escluso

Fissaggio: a parete. Fissaggio a soffitto con profilo tubolare obbligatorio, a supplemento.

CHARACTERISTICS:

Application: vertical

Installation: indoor/outdoor

Headbox: CV140 heavy duty extruded aluminum headbox with removable cover and powder coated aluminum end cheeks

Roller tube: Ø 78/85 mm galvanized steel tube with slot to facilitate fabric removal

Side channels: GS65 extruded aluminum side channels in two parts with winged inner rail in PVC. The ZIP system ensures smooth operation keeping the fabric inside the channels and provides total blackout where required

Hem bar: FZ47 extruded aluminum weighted flat hem bar with PVC end caps and brush. PVC waterproof strip (white, grey, black) on request

Operation: motorised operation; 230V/50Hz tubular motor M50, with top/bottom limit switches and mains cable, thermal cut-out and class IP44 water resistance. Switch excluded

Mounting: wall mounting. Frame for ceiling mounting obligatory, available on request.

note - notes

motore M50 - M50 motor

con tende > 400 cm di larghezza motore da 20 Nm - 20 Nm motor used for widths over 400 cm

la tenda motorizzata viene fornita senza interruttore blind supplied without switch

per fissaggio a soffitto profilo tubolare obbligatorio frame obligatory for ceiling mounting

la guida GS65 consente l'utilizzo di teli finestrati GS65 side channel suitable for fabrics with transparent windows

colori standard - standard colours

bianco Ral 9010 termolaccato - white Ral 9010

argento anodizzato - silver anodised

tessuti abbinabili - suitable fabrics

per l'utilizzo dei tessuti consultare la sezione dei teli confezionati e/o Tabella "A"

for fabric choice consult the fabric section and Tab. "A"

supplementi - supplement

